

EXPECT SOLUTIONS,
NOT JUST
PRODUCTS

Expect... **AVK**

TABLE OF CONTENTS

IN DIGITAL VERSION, PAGE NUMBERS ARE LINKED TO PAGES -
 CLICK ON ANY "Expect AVK" LOGO TO RETURN TO TABLE OF CONTENTS

2 TABLE OF CONTENTS **10 SERIES 145 WARRANTY**

3 RESILIENT WEDGE GATE VALVES FOR FIRE PROTECTION **11 SERIES 34 WARRANTY**

- 145/FFN - FLxFL - NRS
- 145/FFO - FLxFL - OS&Y
- 145/GFN - GRxFL - NRS
- 145/GFO - GRxFL - OS&Y
- 145/GGN - GRxGR - NRS

4 **12 SERIES 45 WARRANTY**

- 145/GGO - GRxGR - OS&Y

5 RESILIENT WEDGE GATE VALVES FOR TELESCOPING INDICATOR POSTS

- 45/FFN/FP - FLxFL - NRS
- 45/MFN/FP - MJxFL - NRS
- 45/MMN/FP - MJxMJ - NRS

5 RESILIENT WEDGE GATE VALVES GROOVED - NRS

- 45/GFN/FP - GVxFL - NRS
- 45/GGN/FP - GVxGV - NRS

6 RESILIENT WEDGE GATE VALVES GROOVED - OS&Y

- 45/FFO/FP - FLxFL - OS&Y
- 45/GFO/FP - GVxFL - OS&Y
- 45/GGO/FP - GVxGV - OS&Y

7 SERIES 34 INDICATOR POSTS

- 340X/TIP - TELESCOPING POST
- 348X/WIP - WALL POST

8 SERIES 45 UL/FM NRS WATER DISTRIBUTION VALVE PRICING

- 45/FFN - FLxFL - NRS
- 45/FFH - FLxFL - NRS - 250 PSI
- 45/MFN - MJxFL - NRS
- 45/MMN - MJxMJ - NRS
- 45/PFN - POxFL - NRS

9 **45/PPN - POxPO - NRS**

- 45/PPN - POxPO - NRS

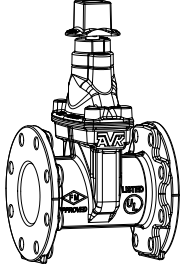
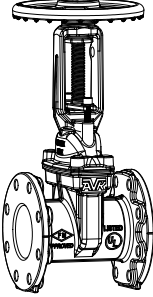
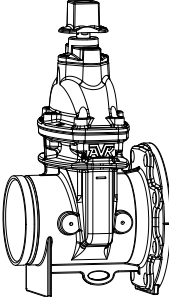
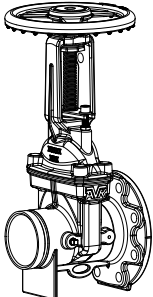
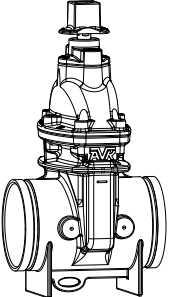
Type	AVK Ref. #	Size	Weight		Price US \$	
			kg	lb		
Series 145/FFN FL X FL, Fire Protection Only Ductile iron body UL listed and FM approved Flanged ends NRS NRS 250 PSI Size 2½"-8"		145-065-FFN	2½"	13	28	440
		145-080-FFN	3"	17	38	480
		145-100-FFN	4"	22	48	880
		145-150-FFN	6"	43	95	1,260
		145-200-FFN	8"	77	169	2,120
		Series 145/FFO FL x FL OS&Y Ductile iron body UL listed and FM approved Flanged ends OS&Y 250 PSI Size 2½"-8"		145-065-FFO	2½"	15
145-080-FFO	3"			19	41	760
145-100-FFO	4"			27	58	900
145-150-FFO	6"			51	112	1,320
145-200-FFO	8"			88	194	2,250
Series 145/GFN GV X FL, Fire Protection Only Ductile iron body UL listed and FM approved to AWWA C606 Grooved ends (IPS) Flanged ends NRS NRS 250 PSI Size 2½"-8"				145-065-GFN	2½"	9
		145-080-GFN	3"	14	29	460
		145-100-GFN	4"	15	32	860
		145-150-GFN	6"	32	70	1,240
		145-200-GFN	8"	70	154	2,100
		Series 145/GFO GV x FL OS&Y Ductile iron body UL listed and FM approved to AWWA C606 Grooved ends (IPS) Flanged ends OS&Y 250 PSI Size 2½"-8"		145-065-GFO	2½"	11
145-080-GFO	3"			14	30	740
145-100-GFO	4"			19	41	880
145-150-GFO	6"			43	94	1,300
145-200-GFO	8"			84	184	2,540
Series 145/GGN GV X GV, Fire Protection Only Ductile iron body UL listed and FM approved to AWWA C606 Grooved ends (IPS) NRS 250 PSI Size 2½"-8"				145-065-GGN	2½"	10
		145-080-GGN	3"	14	29	450
		145-100-GGN	4"	15	32	850
		145-150-GGN	6"	32	70	1,230
		145-200-GGN	8"	70	154	2,090

Type

**Series 145/GFO
GV X GV, Fire Protection
Only
Ductile iron body**

UL listed and
FM approved
to AWWA C606
Grooved ends (IPS)
OS&Y
250 PSI
Size 2½"-8"

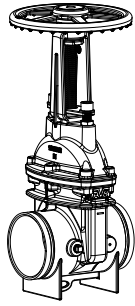

AVK Ref. #

Size

**Weight
kg lb**

**Price
US \$**

145-065-GGO	2½"	11	23	690
145-080-GGO	3"	14	30	730
145-100-GGO	4"	19	41	870
145-150-GGO	6"	43	94	1,290
145-200-GGO	8"	84	184	2,530

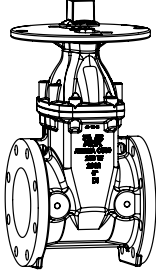
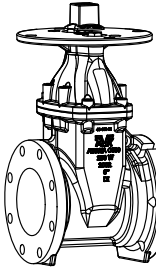
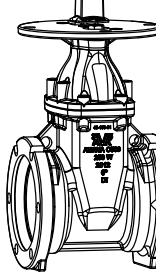
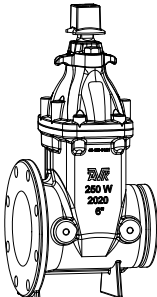
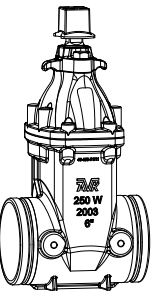
Type	AVK Ref. #	Size	Weight		Price US \$	
			kg	lb		
Series 45/FFP/FP FL X FL, PIV, Full wall ductile iron 125 lb. Flange to AWWA C509/C515 UL listed and FM approved Flanged ends to ASME B 16.42 Class 150 NRS 250 PSI Size 4"-12"		45-100-FFP-FP	4"	38	84	1,421
	45-150-FFP-FP	6"	63	139	1,811	
	45-200-FFP-FP	8"	82	181	2,685	
	45-250-FFP-FP	10"	121	267	4,111	
	45-300-FFP-FP	12"	174	391	4,911	
	Series 45/MFP/FP MJ X FL, PIV, Full wall ductile iron to AWWA C509/C515 UL listed and FM approved Mechanical joint end X Flanged end ASME B 16.42 Class 150 NRS 250 PSI Size 4"-12"		45-100-MFP-FP	4"	28	62
45-150-MFP-FP		6"	47	103	1,755	
45-200-MFP-FP		8"	71	155	2,639	
45-250-MFP-FP		10"	109	240	3,969	
45-300-MFP-FP		12"	153	337	4,953	
less MJ accessories						
Series 45/MMP/FP FMJ X MJ, PIV, Full wall ductile iron to AWWA C509/C515 UL listed and FM approved Mechanical joint ends NRS 250 PSI Size 4"-12"		45-100-MMP-FP	4"	28	62	1,431
	45-150-MMP-FP	6"	47	103	1,755	
	45-200-MMP-FP	8"	71	155	2,639	
	45-250-MMP-FP	10"	109	240	3,969	
	45-300-MMP-FP	12"	153	337	4,953	
	less MJ accessories					
Series 45/GFN/FP IPS GR X FL Ductile iron body UL listed and FM approved to AWWA C606 Grooved ends (IPS) Flanged ends to ASME B 16.42 Class 150 NRS 250 PSI Size 2½"-10"		45-065-GFN-FP	2½"	15	33	1,054
	45-080-GFN-FP	3"	16	35	1,247	
	45-100-GFN-FP	4"	21	55	1,393	
	45-150-GFN-FP	6"	40	87	1,863	
	45-200-GFN-FP	8"	61	133	2,908	
	45-250-GFN-FP	10"	94	208	4,640	
	Series 45/GGN IPS GR X GR Ductile iron body UL listed and FM approved to AWWA C606 Grooved ends (IPS) NRS 250 PSI Size 2½"-10"		45-065-GGN-FP	2½"	14	30
45-080-GGN-FP		3"	16	35	1,247	
45-100-GGN-FP		4"	21	46	1,393	
45-150-GGN-FP		6"	40	87	1,863	
45-200-GGN-FP		8"	61	133	2,908	
45-250-GGN-FP		10"	83	182	4,640	

Type	AVK Ref. #	Size	Weight		Price US \$
			kg	lb	
Series 45/FFO FL X FL OS&Y Full wall ductile iron 125 lb. Flange to AWWA C509/C515 UL listed and FM approved Flanged ends to ASME B 16.42 Class 150 OS&Y 250 PSI Size 2.5"-12"					
	45-065-FFO	2.5"	19	42	1,145
	45-080-FFO	3"	25	56	1,335
	45-100-FFO	4"	35	78	1,527
	45-150-FFO	6"	54	118	1,983
	45-200-FFO	8"	85	187	3,029
	45-250-FFO	10"	152	335	4,451
	45-300-FFO	12"	209	461	5,795
Series 45/GFO/FP IPS GR X FL OS&Y Ductile iron body to AWWA C606 UL listed and FM approved Grooved ends (IPS) Flanged ends to ASME B 16.42 Class 150 NRS 250 PSI Size 2½"-10"					
	45-065-GFO-FP	2½"	21	45	1,151
	45-080-GFO-FP	3"	18	48	1,372
	45-100-GFO-FP	4"	26	64	1,532
	45-150-GFO-FP	6"	47	111	2,040
	45-200-GFO-FP	8"	72	165	3,343
	45-250-GGO	10"	125	275	5,135
	Series 45/GGO/FP IPS GR X GR OS&Y Ductile iron body Grooved ends (IPS) to AWWA C606 UL listed and FM approved OS&Y 250 PSI Size 2½"-10"				
45-065-GGO-FP		2½"	16	35	1,151
45-080-GGO-FP		3"	18	40	1,372
45-100-GGO-FP		4"	26	56	1,532
45-150-GGO-FP		6"	47	103	2,040
45-200-GGO-FP		8"	72	157	3,343
45-250-GGO-FP		10"	119	262	5,135

Type

**Series 34/0X
Telescopic Indicator Post
Above ground
Up-right model**

UL listed and
FM approved

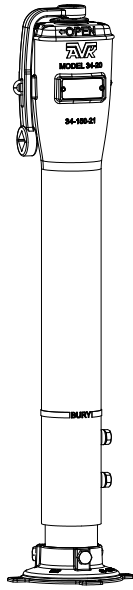

AVK Ref. #	Weight - Poly		Weight - Steel		Price - Poly	Price - Steel
	kg	lb	kg	lb	US \$	US \$

34-0A	xxx	158	xxx	180	1,799	2,210
34-0B	xxx	180	xxx	188	2,077	2,900
34-0C	xxx	219	xxx	219	2,243	3,230
34-0D	xxx	xxx	xxx	258	2,443	3,530
34-0E	xxx	xxx	xxx	xxx	2,643	3,830
34-0F	xxx	xxx	xxx	336	2,843	4,130

Refer to Datasheet for A,B,C,D,E,F minimum-maximum lengths

**Series 34/8X
Indicator post
Wall model**

UL listed and
FM approved

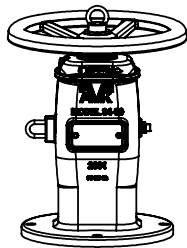

Stem Length
In.

34-130-8X	30"	37.0	81	1,793
34-150-8X	50"	34.0	75	1,883

Contact Customer Service for custom stem length

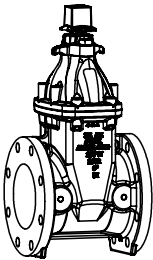
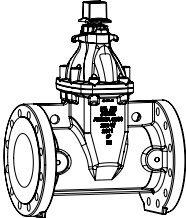
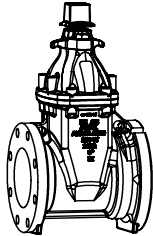
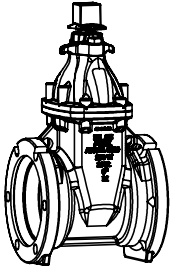
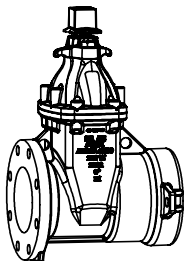
Type	AVK Ref. #	Size	Weight		Price US \$	
			kg	lb		
Series 45/FFN FULL WALL DUCTILE FL X FL To AWWA C509/C515 125 lb. Flange Flanged ends to ASME B 16.42 Class 150 NRS Ductile iron 250 PSI Size 2.5"-16" * ** For 2" FLxFL see Series 25 304 stainless steel stem		45-065-FFN	2.5"	17	38	875
	45-080-FFN	3"	19	42	1,039	
	45-100-FFN	4"	29	63	1,161	
	45-150-FFN	6"	44	97	1,551	
	45-200-FFN	8"	70	154	2,425	
	45-250-FFN	10"	122	269	3,851	
	45-300-FFN	12"	186	409	4,651	
	45-350-FFN*	14"	281	620	14,501	
	45-400-FFN*	16"	358	790	15,729	
	* 14"- 36" discount applies					
Series 45/FFH FULL WALL DUCTILE FL X FL To AWWA C509/C515 250 lb. Flange Flanged ends to ASME B 16.42 Class 250 NRS Ductile iron AWWA 250 PSI CWP 350 PSI Size 4"-12" 304 stainless steel stem		45-100-FFH	4"	41	91	3,900
	45-150-FFH	6"	73	161	4,335	
	45-200-FFH	8"	111	244	5,783	
	45-250-FFH	10"	166	366	9,390	
	45-300-FFH	12"	245	541	10,548	
Series 45/MFN FULL WALL DUCTILE MJ X FL To AWWA C509/C515 Mechanical joint end X Flanged end ASME B 16.42 Class 150 NRS Ductile Iron 250 PSI Size 3"-16" 304 stainless steel stem		45-080-MFN	3"	20	43	995
	45-100-MFN	4"	28	62	1,119	
	45-150-MFN	6"	47	103	1,495	
	45-200-MFN	8"	71	155	2,335	
	45-250-MFN	10"	109	240	3,709	
	45-300-MFN	12"	153	337	4,479	
	45-350-MFN*	14"	381	840	14,501	
	45-400-MFN*	16"	372	820	15,729	
* 14"- 36" discount applies						
Series 45/MMN FULL WALL DUCTILE MJ X MJ To AWWA C509/C515 Mechanical joint ends NRS Ductile iron NRS 250 PSI Size 4"-16" * * For 2" MJxMJ see Series 25 304 stainless steel stem		45-080-MMN	3"	20	43	1,049
	45-100-MMN	4"	28	62	1,171	
	45-150-MMN	6"	47	103	1,495	
	45-200-MMN	8"	71	155	2,379	
	45-250-MMN	10"	109	240	3,709	
	45-300-MMN	12"	153	337	4,693	
	45-350-MMN*	14"	360	794	14,501	
	45-400-MMN*	16"	363	800	15,729	
* 14"- 36" discount applies						
Series 45/PFN FULL WALL DUCTILE PO X FL To AWWA C509/C515 Push-on joint end X Flanged end to ASME B 16.42 Class 150 NRS Ductile Iron 250 PSI Size 4"-12" & 16" 304 stainless steel stem		45-100-PFN	4"	27	59	1,181
	45-150-PFN	6"	45	98	1,557	
	45-200-PFN	8"	70	154	2,459	
	45-250-PFN	10"	105	232	3,867	
	45-300-PFN	12"	163	358	4,757	
	45-400-PFN*	16"	363	800	15,729	
	Gaskets not included with DIP PO Valves * 14"- 36" discount applies					

Type

Series 45/PPN
FULL WALL DUCTILE
PO X PO To AWWA C509/C515

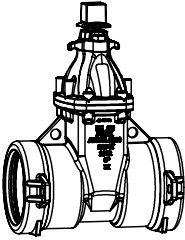

Push-on joint
ends NRS
Ductile Iron
250 PSI
Size 4"-12"&16"
304 stainless steel stem

AVK Ref. #	Size	Weight		Price US \$
		kg	lb	
45-100-PPN	4"	26	57	1,203
45-150-PPN	6"	44	97	1,583
45-200-PPN	8"	71	157	2,403
45-250-PPN	10" *	103	227	3,881
45-300-PPN	12" *	178	391	4,865
45-400-PPN*	16"	446	982	15,729

w/o gasket

Gaskets not included with DIP PO Valves
* Special gaskets available for 10" & 12" IPSxIPS

*** 14"- 36" discount applies**

For OS&Y pricing refer to page 54

UL/FM PRODUCTS FOR WATER DISTRIBUTION



AMERICAN AVK COMPANY TWO (2) YEAR WARRANTY FOR SERIES 145 RESILIENT WEDGE GATE VALVES

American AVK Company warrants its Series 145 Resilient Wedge Gate Valves to be free from defects in workmanship and materials for a period of two (2) years from the date of shipment from American AVK Company. American AVK Company shall have no obligation under this warranty unless it is notified of claims hereunder promptly and in writing upon discovery thereof and within the warranty period, and unless the product is delivered to the American AVK Company facility within thirty (30) days of such notice.

American AVK shall have the right to inspect said product before it is removed from installation. If the product is removed from installation prior to approval from American AVK this warranty shall be void.

As to motors, gearing or accessory equipment purchased by American AVK Company from others manufacturers and used or incorporated into American AVK Company's products, those manufacturers' warranties shall apply.

American AVK Company will honor all reasonable costs to repair or replace any American AVK Company Resilient Wedge Gate Valve found to be defective.

American AVK Company's sole responsibility shall be, in its sole discretion, to replace the product with the same or a similar product, repair the product, or refund the price paid for the product provided the product has been properly applied and used under normal service and under conditions for which it is designed. American AVK Company shall not be liable for indirect, special, incidental, or consequential damage or penalties and does not assume any liability of purchase to others or to anyone for injury to persons or property.

THIS IS THE EXCLUSIVE WARRANTY GIVEN IN CONNECTION WITH THE SALE OF THIS PRODUCT. THERE ARE NO OTHER WARRANTIES, EXPRESSED OR IMPLIED, INCLUDING EXPRESSED OR IMPLIED WARRANTY OF MERCHANTABILITY, OR ANY EXPRESSED OR IMPLIED WARRANTY OF SUITABILITY FOR ANY PARTICULAR PURPOSE, GIVEN BY AMERICAN AVK COMPANY IN CONNECTION WITH THIS PRODUCT.

American AVK Company

2155 Mendham Blvd.
Minden, NJ 08942

Tel: 7731 552-1400
Fax: 7731 783-1031

sales@avk.com
www.americanavk.com

Expect... 



AMERICAN AVK COMPANY ONE (1) WARRANTY YEAR SERIES 3400/3480 POST INDICATOR

American AVK Company warrants its Series 3400 and 3480 Post Indicator to be free from defects in workmanship and materials for a period of one (1) year from the date of shipment from American AVK Company. American AVK Company shall have no obligation under this warranty unless it is notified of claims hereunder promptly and in writing upon discovery thereof and within the warranty period, and unless the product is delivered to American AVK Company within thirty (30) days of such notice.

American AVK shall have the right to inspect said product before it is removed from installation. If the product is removed from installation prior to approval from American AVK this warranty shall be void.

As to motors, gearing or accessory equipment purchased by American AVK Company from other manufacturers, and used or incorporated into American AVK Company's products, those manufacturers' warranties shall apply.

American AVK Company's sole responsibility shall be, in its sole discretion, to replace the product with the same or a similar product, repair the product, or refund the price paid for the product provided the product has been properly applied and used under normal service and under conditions for which it is designed. American AVK Company shall not be liable for indirect, special, incidental, or consequential damage or penalties and does not assume any liability of purchase to others or to anyone for injury to persons or property.

THIS IS THE EXCLUSIVE WARRANTY GIVEN IN CONNECTION WITH THE SALE OF THIS PRODUCT. THERE ARE NO OTHER WARRANTIES, EXPRESSED OR IMPLIED, INCLUDING EXPRESSED OR IMPLIED WARRANTY OF MERCHANTABILITY, OR ANY EXPRESSED OR IMPLIED WARRANTY OF SUITABILITY FOR ANY PARTICULAR PURPOSE, GIVEN BY AMERICAN AVK COMPANY IN CONNECTION WITH THIS PRODUCT.

American AVK Company

2155 Meridian Blvd
Minden, NV 89423

Tel: (775) 552-1400
Fax: (775) 783-1031

sales@avkus.com
www.americanavk.com





AMERICAN AVK COMPANY TEN (10) YEAR WARRANTY RESILIENT WEDGE GATE VALVES

American AVK Company warrants its Series 03, Series 25, Series 45, Series 55, Series 65, and Series 66 Resilient Wedge Gate Valves to be free from defects in workmanship and materials for a period of ten (10) years from the date of shipment from American AVK Company. American AVK Company shall have no obligation under this warranty unless it is notified of claims hereunder promptly and in writing upon discovery thereof and within the warranty period, and unless the product is delivered to the American AVK Company facility within thirty (30) days of such notice.

American AVK shall have the right to inspect said product before it is removed from installation. If the product is removed from installation prior to approval from American AVK this warranty shall be void.

As to motors, gearing or accessory equipment purchased by American AVK Company from others manufacturers, and used or incorporated into American AVK Company's products, those manufacturers' warranties shall apply.

American AVK Company will honor all reasonable costs to repair or replace any American AVK Company Resilient Wedge Gate Valve found to be defective.

American AVK Company's sole responsibility shall be, in its sole discretion, to replace the product with the same or a similar product, repair the product, or refund the price paid for the product provided the product has been properly applied and used under normal service and under conditions for which it is designed. American AVK Company shall not be liable for indirect, special, incidental, or consequential damage or penalties and does not assume any liability of purchase to others or to anyone for injury to persons or property.

THIS IS THE EXCLUSIVE WARRANTY GIVEN IN CONNECTION WITH THE SALE OF THIS PRODUCT. THERE ARE NO OTHER WARRANTIES, EXPRESSED OR IMPLIED, INCLUDING EXPRESSED OR IMPLIED WARRANTY OF MERCHANTABILITY, OR ANY EXPRESSED OR IMPLIED WARRANTY OF SUITABILITY FOR ANY PARTICULAR PURPOSE, GIVEN BY AMERICAN AVK COMPANY IN CONNECTION WITH THIS PRODUCT.

American AVK Company

2155 Meridian Blvd
Minden, NV 89423

Tel: (775) 552-1400
Fax: (775) 783-1031

sales@avkus.com
www.americanavk.com

Expect... The logo for American AVK Company, featuring the letters 'AVK' in a bold, blue, stylized font. The 'A' and 'V' are connected, and the 'K' is separate.