

Type

AVK Ref. #

Size

**Weight
kg lb**

**Price
US \$**

**Series 27N/PPN
(2756) Nostalgic style
Ductile iron**

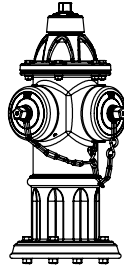

To AWWA C502
UL listed
Dry barrel hydrant
2 Pumper Nozzle ONLY**
No Hose Nozzles
Standard bases available:
4" FL* or 4" MJ*
6" FL
6" MJ
6" PO

Optional bases available:
4" PE*
6" PE*
6" Straight*
6" HYMAX GRIP®*
8" MJ*
250 PSI
* Not UL/FM*
**FM does not approve hydrants
without hose nozzles

27N/PPN-01	1.5'	127	280	3,915
27N/PPN-02	2.0'	136	300	3,915
27N/PPN-03	2.5'	145	320	3,915
27N/PPN-04	3.0'	154	340	4,015
27N/PPN-05	3.5'	163	360	4,117
27N/PPN-06	4.0'	172	380	4,219
27N/PPN-07	4.5'	181	400	4,321
27N/PPN-08	5.0'	190	420	4,423
27N/PPN-09	5.5'	200	440	4,525
27N/PPN-10	6.0'	209	460	4,627
27N/PPN-11	6.5'	218	480	4,729
27N/PPN-12	7.0'	227	500	4,831
27N/PPN-13	7.5'	236	520	4,933
27N/PPN-14	8.0'	245	540	5,035
27N/PPN-15	8.5'	254	560	5,137
27N/PPN-16	9.0'	263	580	5,239
27N/PPN-17	9.5'	272	600	5,341
27N/PPN-18	10.0'	281	620	5,443
27N/PPN-19	10.5'	290	640	5,545
27N/PPN-20	11.0'	300	660	5,647
27N/PPN-21	11.5'	309	680	5,749
27N/PPN-22	12.0'	318	700	5,851

All adders are added to List Pricing

Note: Trade prices without accessories. For each 6" increase to bury depth over 12' add \$102
Add \$300 for 6" HYMAX GRIP® base

**Series 27M/PHH
(2700) Modern style
Ductile iron**

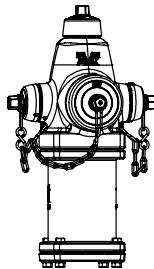

To AWWA C502
UL listed
FM approved
Dry barrel hydrant
2 Hose Nozzles
1 Pumper Nozzle
Standard bases available:
4" FL* or 4" MJ*
6" FL
6" MJ
6" PO

Optional bases available:
4" PE*
6" PE*
6" Straight*
6" HYMAX GRIP®*
8" MJ*
250 PSI
* Not UL/FM

27M/PHH-01	1.5'	127	280	4,087
27M/PHH-02	2.0'	136	300	4,087
27M/PHH-03	2.5'	145	320	4,087
27M/PHH-04	3.0'	154	340	4,189
27M/PHH-05	3.5'	163	360	4,291
27M/PHH-06	4.0'	172	380	4,393
27M/PHH-07	4.5'	181	400	4,495
27M/PHH-08	5.0'	190	420	4,597
27M/PHH-09	5.5'	200	440	4,699
27M/PHH-10	6.0'	209	460	4,801
27M/PHH-11	6.5'	218	480	4,903
27M/PHH-12	7.0'	227	500	5,005
27M/PHH-13	7.5'	236	520	5,107
27M/PHH-14	8.0'	245	540	5,209
27M/PHH-15	8.5'	254	560	5,311
27M/PHH-16	9.0'	263	580	5,413
27M/PHH-17	9.5'	272	600	5,515
27M/PHH-18	10.0'	281	620	5,617
27M/PHH-19	10.5'	290	640	5,719
27M/PHH-20	11.0'	300	660	5,821
27M/PHH-21	11.5'	309	680	5,923
27M/PHH-22	12.0'	318	700	6,025

All adders are added to List Pricing

Note: Trade prices without accessories. For each 6" increase to bury depth over 12' add \$102
Add \$300 for 6" HYMAX GRIP® base
Add \$51 for 16" Upper Barrel
Add \$102 for 22" Upper Barrel

Type

**Series 27M/PNN
(2712) Modern style
Ductile iron**



To AWWA C502
 Dry barrel hydrant
 1 Pumper Nozzle ONLY
 No Hose Nozzles
 Standard bases available:
 4" FL or 4" MJ
 6" FL
 6" MJ
 6" PO

Optional bases available:
 4" PE
 6" PE
 6" Straight
 6" HYMAX GRIP®*
 8" MJ
 250 PSI
 UL/FM do not recognize Single
 Pumper configurations

AVK Ref. #

Size

Weight

kg lb

**Price
US \$**

AVK Ref. #	Size	Weight kg	Weight lb	Price US \$
27M/PNN-01	1.5'	127	280	3,787
27M/PNN-02	2.0'	136	300	3,787
27M/PNN-03	2.5'	145	320	3,787
27M/PNN-04	3.0'	154	340	3,889
27M/PNN-05	3.5'	163	360	3,991
27M/PNN-06	4.0'	172	380	4,093
27M/PNN-07	4.5'	181	400	4,195
27M/PNN-08	5.0'	190	420	4,297
27M/PNN-09	5.5'	200	440	4,399
27M/PNN-10	6.0'	209	460	4,501
27M/PNN-11	6.5'	218	480	4,603
27M/PNN-12	7.0'	227	500	4,705
27M/PNN-13	7.5'	236	520	4,807
27M/PNN-14	8.0'	245	540	4,909
27M/PNN-15	8.5'	254	560	5,011
27M/PNN-16	9.0'	263	580	5,113
27M/PNN-17	9.5'	272	600	5,215
27M/PNN-18	10.0'	281	620	5,317
27M/PNN-19	10.5'	290	640	5,419
27M/PNN-20	11.0'	300	660	5,521
27M/PNN-21	11.5'	309	680	5,623
27M/PNN-22	12.0'	318	700	5,725

All adders are added to List Pricing
 Note: Trade prices without accessories. For each 6" increase to bury depth over 12' add \$102
 Add \$300 for 6" HYMAX GRIP® base
 Add \$51 for 16" Upper Barrel
 Add \$102 for 22" Upper Barrel

**Series 27N/PPN
(2736) Modern style
Ductile iron**

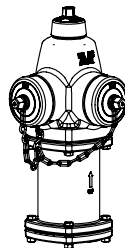

To AWWA C502
 UL listed
 Dry barrel hydrant
 2 Pumper Nozzle ONLY**
 No Hose Nozzles
 Standard bases available:
 4" FL* or 4" MJ*
 6" FL
 6" MJ
 6" PO
 6" PE

Optional bases available:
 4" PE*
 6" PE*
 6" Straight*
 6" HYMAX GRIP®*
 8" MJ*
 250 PSI
 * Not UL/FM*
 **FM does not approve hydrants
 without hose nozzles

AVK Ref. #	Size	Weight kg	Weight lb	Price US \$
27N/PPN-01	1.5'	127	280	3,915
27N/PPN-02	2.0'	136	300	3,915
27N/PPN-03	2.5'	145	320	3,915
27N/PPN-04	3.0'	154	340	4,015
27N/PPN-05	3.5'	163	360	4,117
27N/PPN-06	4.0'	172	380	4,219
27N/PPN-07	4.5'	181	400	4,321
27N/PPN-08	5.0'	190	420	4,423
27N/PPN-09	5.5'	200	440	4,525
27N/PPN-10	6.0'	209	460	4,627
27N/PPN-11	6.5'	218	480	4,729
27N/PPN-12	7.0'	227	500	4,831
27N/PPN-13	7.5'	236	520	4,933
27N/PPN-14	8.0'	245	540	5,035
27N/PPN-15	8.5'	254	560	5,137
27N/PPN-16	9.0'	263	580	5,239
27N/PPN-17	9.5'	272	600	5,341
27N/PPN-18	10.0'	281	620	5,443
27N/PPN-19	10.5'	290	640	5,545
27N/PPN-20	11.0'	300	660	5,647
27N/PPN-21	11.5'	309	680	5,749
27N/PPN-22	12.0'	318	700	5,851

All adders are added to List Pricing
 Note: Trade prices without accessories. For each 6" increase to bury depth over 12' add \$102
 Add \$300 for 6" HYMAX GRIP® base
 Add \$51 for 16" Upper Barrel
 Add \$102 for 22" Upper Barrel

Type

**Series 27M/PHH-ALP
(2730) Modern style
Ductile iron**

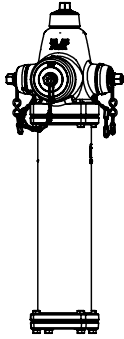

To AWWA C502
Dry barrel hydrant
2 Hose Nozzles
1 Pumper Nozzle
Extended Alpine Upper Barrel
Standard bases available:
4" FL* or 4" MJ*
6" FL
6" MJ
6" PO

Optional bases available:
4" PE*
6" PE*
6" Straight*
6" HYMAX GRIP®*
8" MJ*
250 PSI
* Not UL/FM*
**FM does not approve hydrants
without hose nozzles

AVK Ref. #	Size	Weight		Price US \$
		kg	lb	
27M/PHH-01-ALP	1.5'	127	280	4,587
27M/PHH-02-ALP	2.0'	136	300	4,587
27M/PHH-03-ALP	2.5'	145	320	4,587
27M/PHH-04-ALP	3.0'	154	340	4,689
27M/PHH-05-ALP	3.5'	163	360	4,791
27M/PHH-06-ALP	4.0'	172	380	4,893
27M/PHH-07-ALP	4.5'	181	400	4,995
27M/PHH-08-ALP	5.0'	190	420	5,097
27M/PHH-09-ALP	5.5'	200	440	5,199
27M/PHH-10-ALP	6.0'	209	460	5,301
27M/PHH-11-ALP	6.5'	218	480	5,403
27M/PHH-12-ALP	7.0'	227	500	5,505
27M/PHH-13-ALP	7.5'	236	520	5,607
27M/PHH-14-ALP	8.0'	245	540	5,709
27M/PHH-15-ALP	8.5'	254	560	5,811
27M/PHH-16-ALP	9.0'	263	580	5,913
27M/PHH-17-ALP	9.5'	272	600	6,015
27M/PHH-18-ALP	10.0'	281	620	6,117
27M/PHH-19-ALP	10.5'	290	640	6,219
27M/PHH-20-ALP	11.0'	300	660	6,321
27M/PHH-21-ALP	11.5'	309	680	6,423
27M/PHH-22-ALP	12.0'	318	700	6,525

All adders are added to List Pricing
Note: Trade prices without accessories. For each 6" increase to bury depth over 12' add \$102
Add \$300 for 6" HYMAX GRIP® base

**Series 27M/PHH
(27CA - Monitor Elbow)
Modern style
Ductile iron**

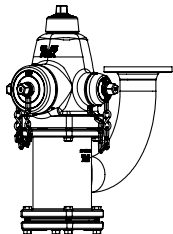

To AWWA C502
UL listed
FM approved
Dry barrel hydrant
2 Hose Nozzles
1 Pumper Nozzle
Monitor Elbow 3" or 4"
Standard bases available:
4" FL* or 4" MJ*
6" FL
6" MJ
6" PO

Optional bases available:
4" PE*
6" PE*
6" Straight*
6" HYMAX GRIP®*
8" MJ*
250 PSI
* Not UL/FM

27M/PHH-01	1.5'	127	280	5,487
27M/PHH-02	2.0'	136	300	5,487
27M/PHH-03	2.5'	145	320	5,487
27M/PHH-04	3.0'	154	340	5,589
27M/PHH-05	3.5'	163	360	5,691
27M/PHH-06	4.0'	172	380	5,793
27M/PHH-07	4.5'	181	400	5,895
27M/PHH-08	5.0'	190	420	5,997
27M/PHH-09	5.5'	200	440	6,099
27M/PHH-10	6.0'	209	460	6,201
27M/PHH-11	6.5'	218	480	6,303
27M/PHH-12	7.0'	227	500	6,405
27M/PHH-13	7.5'	236	520	6,507
27M/PHH-14	8.0'	245	540	6,609
27M/PHH-15	8.5'	254	560	6,711
27M/PHH-16	9.0'	263	580	6,813
27M/PHH-17	9.5'	272	600	6,915
27M/PHH-18	10.0'	281	620	7,017
27M/PHH-19	10.5'	290	640	7,119
27M/PHH-20	11.0'	300	660	7,219
27M/PHH-21	11.5'	309	680	7,321
27M/PHH-22	12.0'	318	700	7,423

All adders are added to List Pricing
Note: Trade prices without accessories. For each 6" increase to bury depth over 12' add \$102
Add \$300 for 6" HYMAX GRIP® base

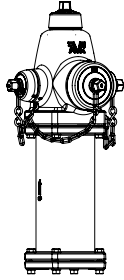
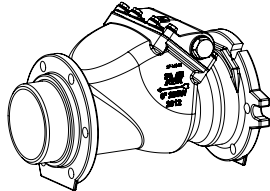
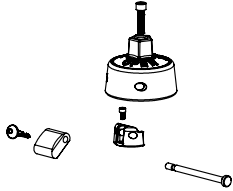
<p>Type</p> <p>Series 27M/PHH-EXT (2702 - Extended Upper Barrel) Modern style Ductile iron</p>  <p>To AWWA C502 UL listed FM approved Dry barrel hydrant 2 Hose Nozzles 1 Pumper Nozzle Standard bases available: 4" FL* or 4" MJ* 6" FL 6" MJ 6" PO</p> <p>Optional bases available: 4" PE* 6" PE* 6" Straight* 6" HYMAX GRIP®* 8" MJ* 250 PSI * Not UL/FM</p>	<table border="1"> <thead> <tr> <th data-bbox="600 157 779 189">AVK Ref. #</th> <th data-bbox="901 157 950 189">Size</th> <th colspan="2" data-bbox="1144 157 1242 210">Weight</th> <th data-bbox="1453 157 1518 210">Price US \$</th> </tr> <tr> <td></td> <td></td> <th data-bbox="1112 178 1144 210">kg</th> <th data-bbox="1209 178 1242 210">lb</th> <td></td> </tr> </thead> <tbody> <tr><td>27M/PHH-01-EXT</td><td>1.5'</td><td>127</td><td>280</td><td>4,189</td></tr> <tr><td>27M/PHH-02-EXT</td><td>2.0'</td><td>136</td><td>300</td><td>4,189</td></tr> <tr><td>27M/PHH-03-EXT</td><td>2.5'</td><td>145</td><td>320</td><td>4,189</td></tr> <tr><td>27M/PHH-04-EXT</td><td>3.0'</td><td>154</td><td>340</td><td>4,291</td></tr> <tr><td>27M/PHH-05-EXT</td><td>3.5'</td><td>163</td><td>360</td><td>4,393</td></tr> <tr><td>27M/PHH-06-EXT</td><td>4.0'</td><td>172</td><td>380</td><td>4,495</td></tr> <tr><td>27M/PHH-07-EXT</td><td>4.5'</td><td>181</td><td>400</td><td>4,597</td></tr> <tr><td>27M/PHH-08-EXT</td><td>5.0'</td><td>190</td><td>420</td><td>4,699</td></tr> <tr><td>27M/PHH-09-EXT</td><td>5.5'</td><td>200</td><td>440</td><td>4,801</td></tr> <tr><td>27M/PHH-10-EXT</td><td>6.0'</td><td>209</td><td>460</td><td>4,903</td></tr> <tr><td>27M/PHH-11-EXT</td><td>6.5'</td><td>218</td><td>480</td><td>5,005</td></tr> <tr><td>27M/PHH-12-EXT</td><td>7.0'</td><td>227</td><td>500</td><td>5,107</td></tr> <tr><td>27M/PHH-13-EXT</td><td>7.5'</td><td>236</td><td>520</td><td>5,209</td></tr> <tr><td>27M/PHH-14-EXT</td><td>8.0'</td><td>245</td><td>540</td><td>5,311</td></tr> <tr><td>27M/PHH-15-EXT</td><td>8.5'</td><td>254</td><td>560</td><td>5,413</td></tr> <tr><td>27M/PHH-16-EXT</td><td>9.0'</td><td>263</td><td>580</td><td>5,515</td></tr> <tr><td>27M/PHH-17-EXT</td><td>9.5'</td><td>272</td><td>600</td><td>5,617</td></tr> <tr><td>27M/PHH-18-EXT</td><td>10.0'</td><td>281</td><td>620</td><td>5,719</td></tr> <tr><td>27M/PHH-19-EXT</td><td>10.5'</td><td>290</td><td>640</td><td>5,821</td></tr> <tr><td>27M/PHH-20-EXT</td><td>11.0'</td><td>300</td><td>660</td><td>5,923</td></tr> <tr><td>27M/PHH-21-EXT</td><td>11.5'</td><td>309</td><td>680</td><td>6,025</td></tr> <tr><td>27M/PHH-22-EXT</td><td>12.0'</td><td>318</td><td>700</td><td>6,127</td></tr> </tbody> </table> <p>All adders are added to List Pricing Note: Trade prices without accessories. For each 6" increase to bury depth over 12' add \$102 Add \$300 for 6" HYMAX GRIP® base</p>	AVK Ref. #	Size	Weight		Price US \$			kg	lb		27M/PHH-01-EXT	1.5'	127	280	4,189	27M/PHH-02-EXT	2.0'	136	300	4,189	27M/PHH-03-EXT	2.5'	145	320	4,189	27M/PHH-04-EXT	3.0'	154	340	4,291	27M/PHH-05-EXT	3.5'	163	360	4,393	27M/PHH-06-EXT	4.0'	172	380	4,495	27M/PHH-07-EXT	4.5'	181	400	4,597	27M/PHH-08-EXT	5.0'	190	420	4,699	27M/PHH-09-EXT	5.5'	200	440	4,801	27M/PHH-10-EXT	6.0'	209	460	4,903	27M/PHH-11-EXT	6.5'	218	480	5,005	27M/PHH-12-EXT	7.0'	227	500	5,107	27M/PHH-13-EXT	7.5'	236	520	5,209	27M/PHH-14-EXT	8.0'	245	540	5,311	27M/PHH-15-EXT	8.5'	254	560	5,413	27M/PHH-16-EXT	9.0'	263	580	5,515	27M/PHH-17-EXT	9.5'	272	600	5,617	27M/PHH-18-EXT	10.0'	281	620	5,719	27M/PHH-19-EXT	10.5'	290	640	5,821	27M/PHH-20-EXT	11.0'	300	660	5,923	27M/PHH-21-EXT	11.5'	309	680	6,025	27M/PHH-22-EXT	12.0'	318	700	6,127
AVK Ref. #	Size	Weight		Price US \$																																																																																																																					
		kg	lb																																																																																																																						
27M/PHH-01-EXT	1.5'	127	280	4,189																																																																																																																					
27M/PHH-02-EXT	2.0'	136	300	4,189																																																																																																																					
27M/PHH-03-EXT	2.5'	145	320	4,189																																																																																																																					
27M/PHH-04-EXT	3.0'	154	340	4,291																																																																																																																					
27M/PHH-05-EXT	3.5'	163	360	4,393																																																																																																																					
27M/PHH-06-EXT	4.0'	172	380	4,495																																																																																																																					
27M/PHH-07-EXT	4.5'	181	400	4,597																																																																																																																					
27M/PHH-08-EXT	5.0'	190	420	4,699																																																																																																																					
27M/PHH-09-EXT	5.5'	200	440	4,801																																																																																																																					
27M/PHH-10-EXT	6.0'	209	460	4,903																																																																																																																					
27M/PHH-11-EXT	6.5'	218	480	5,005																																																																																																																					
27M/PHH-12-EXT	7.0'	227	500	5,107																																																																																																																					
27M/PHH-13-EXT	7.5'	236	520	5,209																																																																																																																					
27M/PHH-14-EXT	8.0'	245	540	5,311																																																																																																																					
27M/PHH-15-EXT	8.5'	254	560	5,413																																																																																																																					
27M/PHH-16-EXT	9.0'	263	580	5,515																																																																																																																					
27M/PHH-17-EXT	9.5'	272	600	5,617																																																																																																																					
27M/PHH-18-EXT	10.0'	281	620	5,719																																																																																																																					
27M/PHH-19-EXT	10.5'	290	640	5,821																																																																																																																					
27M/PHH-20-EXT	11.0'	300	660	5,923																																																																																																																					
27M/PHH-21-EXT	11.5'	309	680	6,025																																																																																																																					
27M/PHH-22-EXT	12.0'	318	700	6,127																																																																																																																					
<p>Series 27 FlowGuard I™ Dry Barrel Hydrant Check Valve</p> 	<table border="1"> <tbody> <tr> <td>27-150-C9</td> <td>For all AVK dry barrel hydrants</td> <td>51</td> <td>112</td> <td>2,650</td> </tr> </tbody> </table> <p>All adders are added to List Pricing For 316 Stainless Steel Bolts add \$161 Use Check Valve Parts Discount</p>	27-150-C9	For all AVK dry barrel hydrants	51	112	2,650																																																																																																																			
27-150-C9	For all AVK dry barrel hydrants	51	112	2,650																																																																																																																					
<p>Series 27 Dry Barrel Hydrant Options</p>	<table border="1"> <tbody> <tr><td>For 8" MJ shoe less accessories</td><td>add 250</td></tr> <tr><td>For Straight Inlet</td><td>add 350</td></tr> <tr><td>For 4" PE Inlet</td><td>add 451</td></tr> <tr><td>For 6" PE Inlet</td><td>add 451</td></tr> <tr><td>For 6" HYMAX GRIP® Inlet</td><td>add 300</td></tr> <tr><td>Handwheel Kit</td><td>add 401</td></tr> <tr><td>For Integral Storz Connection 2.5"</td><td>add 601</td></tr> <tr><td>For Integral Storz Connection 4"</td><td>add 731</td></tr> <tr><td>For Integral Storz Connection 5"</td><td>add 821</td></tr> </tbody> </table> <p>All adders are added to List Pricing</p>	For 8" MJ shoe less accessories	add 250	For Straight Inlet	add 350	For 4" PE Inlet	add 451	For 6" PE Inlet	add 451	For 6" HYMAX GRIP® Inlet	add 300	Handwheel Kit	add 401	For Integral Storz Connection 2.5"	add 601	For Integral Storz Connection 4"	add 731	For Integral Storz Connection 5"	add 821																																																																																																						
For 8" MJ shoe less accessories	add 250																																																																																																																								
For Straight Inlet	add 350																																																																																																																								
For 4" PE Inlet	add 451																																																																																																																								
For 6" PE Inlet	add 451																																																																																																																								
For 6" HYMAX GRIP® Inlet	add 300																																																																																																																								
Handwheel Kit	add 401																																																																																																																								
For Integral Storz Connection 2.5"	add 601																																																																																																																								
For Integral Storz Connection 4"	add 731																																																																																																																								
For Integral Storz Connection 5"	add 821																																																																																																																								
<p>Series 27 Tamper Guard</p> 	<table border="1"> <tbody> <tr> <td>27-000-47X</td> <td>Tamper Guard w/o Lock</td> <td>221</td> </tr> <tr> <td>27-000-47X</td> <td>Tamper Guard with Lock</td> <td>261</td> </tr> </tbody> </table> <p>Use Fire Hydrant Parts Discount</p>	27-000-47X	Tamper Guard w/o Lock	221	27-000-47X	Tamper Guard with Lock	261																																																																																																																		
27-000-47X	Tamper Guard w/o Lock	221																																																																																																																							
27-000-47X	Tamper Guard with Lock	261																																																																																																																							